

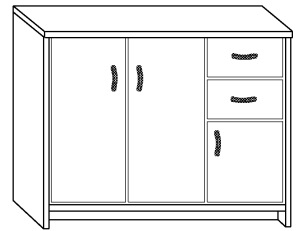

KOMODA K2-3D-2S

→ 109 + 106 \ 36



x 15

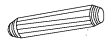

x 2 kpl. (300 mm)

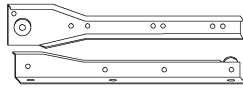

x 5

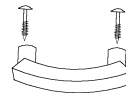

(a)

(b)

(c)

x 4

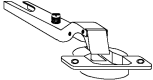

x 2



x 6

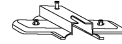

x 5

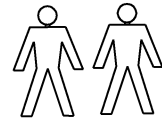

50 min



(d)

(e)

(f)

(g)

x 4



x 24
(3,5x30)



x 36
(4x16)



x 16



x 60

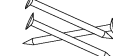

x 1

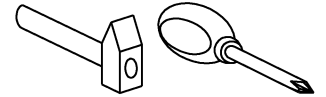

(h)

(i)

(j)

(k)

(l)

(m)

① - FAZY MONTAŻU

Ⓐ - OZNACZENIE ELEMENTÓW

ⓐ - OZNACZENIE AKCESORIÓW

①

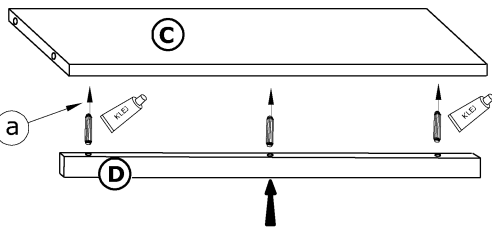

②

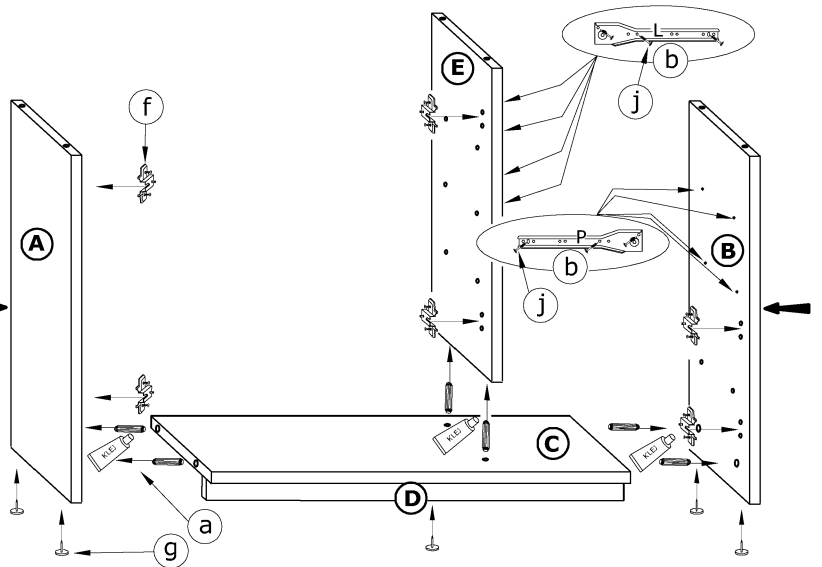

③

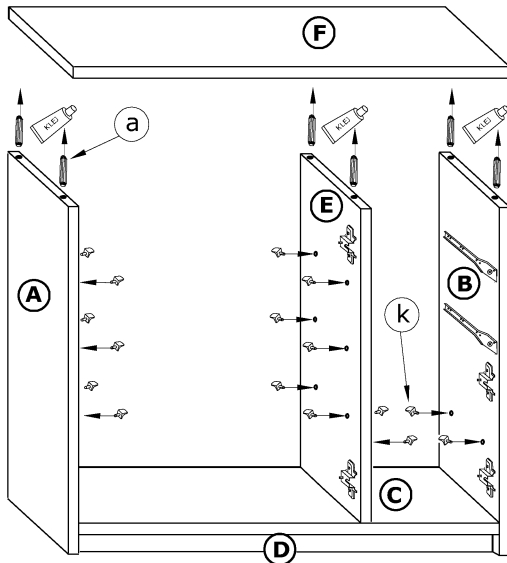

④

